

JOSKIN

www.joskin.com

SLURRY

TRANSPORT AND SPREADING

SLURRY TANKER ACTION

- € 150 to - € 250 NET/m³

Up to € 7,628 NET discount! Offer valid until 31.01.2025.
Offer subject to conditions.



A Concentrate of Technique thanks to 40 Years of Experience!

9 ranges, 6 pump systems, 62 models and over 900 options

Pump Systems

To choose the right slurry tanker, it is first and foremost **essential to choose the right type of pump**. JOSKIN offers several systems for different uses and conditions.

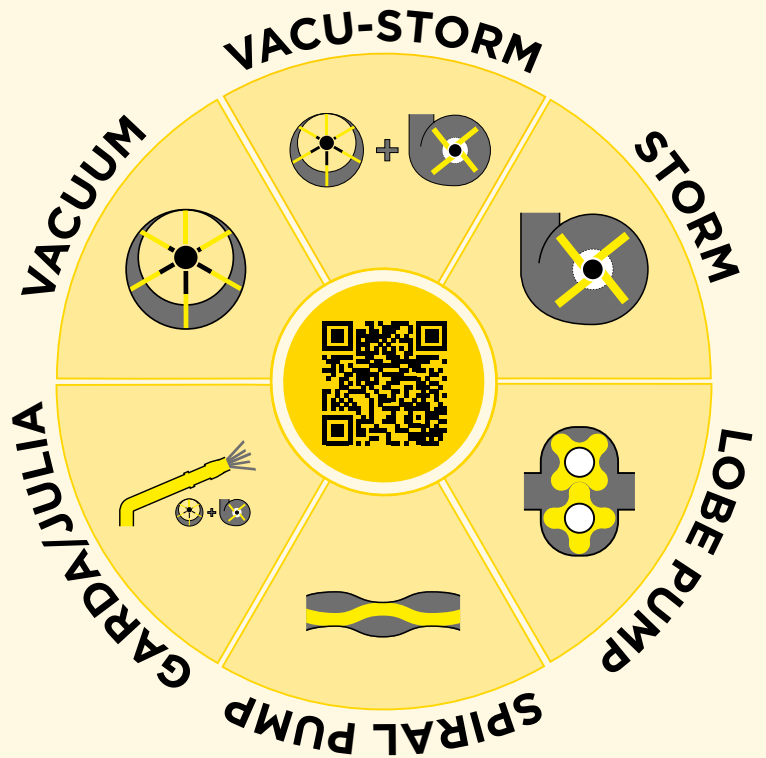

VACUUM

The vacuum system creates an atmospheric pressure difference between the inside of the tank and the surrounding air. This means that the pump does not come into contact with the liquid being sucked in/discharged and therefore does not encounter foreign materials.

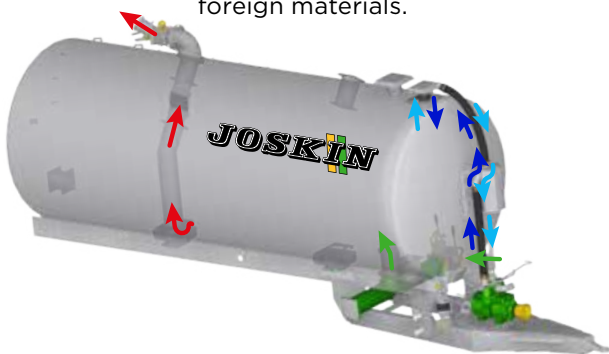

- Very good price/efficiency ratio
 - Limited wear and low maintenance costs
 - User-friendly system
 - Suitable for many pumping situations
- Available on all JOSKIN slurry tankers**

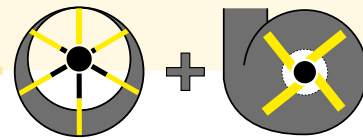

VACU-STORM

The Vacu-Storm system combines the effects of a vacuum pump on the suction side and a centrifugal pump (Storm) on the discharge side. It is an ideal solution for users looking for flexibility and high performances.

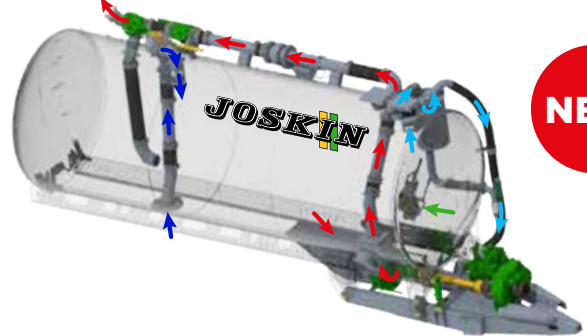

- Efficient: possibility to spread over large widths
 - Easy and low-cost maintenance
 - High and constant slurry flow
 - Flexible: suitable for all pumping situations
 - Storm pressure: ideally 2.2 bar
- Available on Volumetra, X-Trem2 and Euroliner**

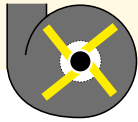

CENTRIFUGAL PUMP (STORM)

The Storm system propels the slurry out of the pump by the centrifugal force created by the rotation of a screw inside an eccentric pump body. This system allows higher flow rates to be achieved.

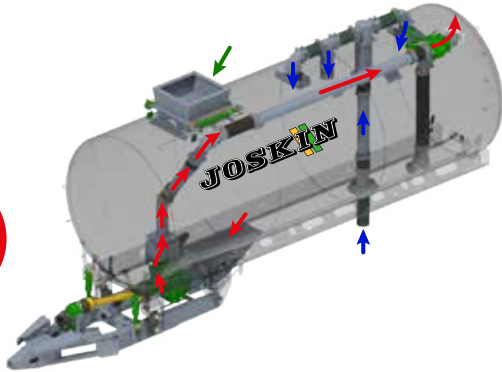

- Efficient: possibility to spread over large widths
- Limited wear and low maintenance costs
- Good distribution over a wide working width
- Pressure: ideally 2.2 bar

Available on Modulo2, Volumetra and Euroliner



LOBE PUMP

This system uses the mechanical action of 2 lobe rotors whose rotation creates a vacuum on the suction side to draw the slurry into the pump body. The pump does not take much place even if it has a high capacity, and can be used to transfer slurry.

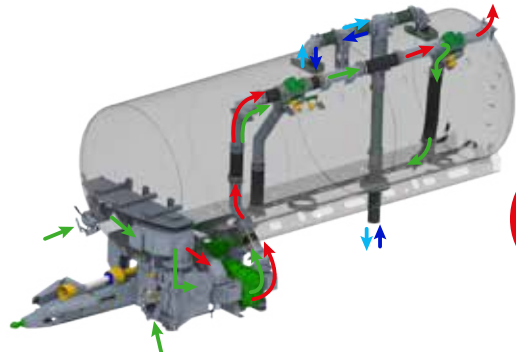

- High suction/discharge flow
- Possibility to suck up thick slurry
- High suction depths possible
- Pressure: ideally 2 bar (max. 6 bar)

Available on Volumetra, Tetrax2, Cobra2, X-Trem2, Euroliner and Tetraliner



SPIRAL PUMP

The spiral pump uses the mechanical action of an eccentric screw to suck in and discharge the slurry. This pump can suck and discharge thick slurry, even through long pipes, as well as carry out transfers from one pit to another.

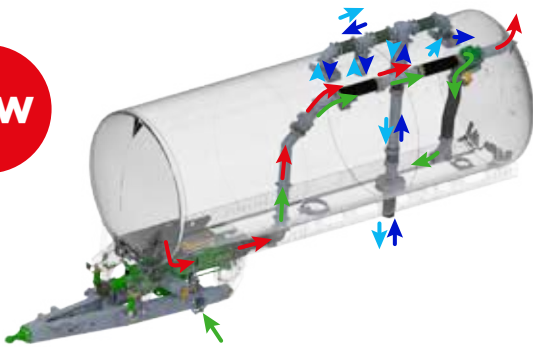

- High suction/discharge speed
- Easy and low-cost maintenance
- High suction depths possible
- Pressure: ideally 2 bar (max. 6 bar)

Available on Modulo2, Volumetra and Cobra2

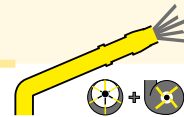

GARDA/JULIA

The Garda/Julia system with mechanical drive combines 2 pumps: centrifugal and vacuum. The centrifugal force can be increased to 6 bar for watering and spreading in mountainous areas.

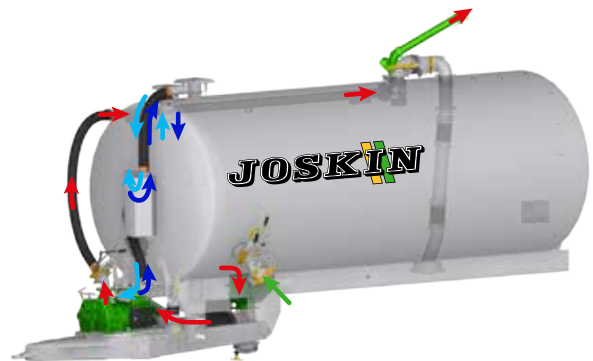

- Versatile (centrifugal or vacuum pump)
 - Low maintenance costs
 - Ideal for irrigation works
- Ideal for steep areas with difficult access
 - Centrifugal pressure: max. 6 bar

Available on Alpina2, Modulo2 and Volumetra



Filling Arms Ø 200 or 250 mm

For added convenience, JOSKIN slurry tankers* can be fitted with an optional filling arm. This equipment is a **particularly interesting time-saver**: you can now fill your tanker while still in your tractor!

*Except Alpina2.

MORE INFORMATION

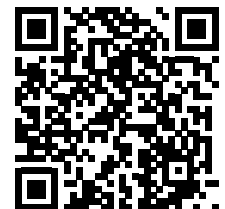

Self-Supporting Arm on Tractor Front Linkage: the Best Visibility



The self-supporting arm on the tractor front linkage means **less manoeuvres**, and the arm can remain unfolded for refilling purposes. In addition to this considerable time saving, the best asset of this system is undoubtedly the **visibility**, thanks to its offset to the right and its scissor-like folding system in front of the tractor's front wheels.

- Possibility to equip slurry tankers without filling arm with a wide boom
- Good visibility on the arm
- Minimal space requirement thanks to the double-folding design





Left and Right 8" (200 mm) Front JUMBO: the Most Economical Choice

The JUMBO is a reasonable investment for **avoiding the need to couple hoses**, especially when a heavy Ø 200 mm hose is involved.

- Reversible front arm for pumping on the left- or right-hand side
- Sucking slurry via a funnel connected to the storage tank or placed on the ground
- Control via sequential block
- Hydraulic filter for a longer life of the hydraulic system
- **Easy, safe and automatic arm**



Articulated Filling Arm: the Most Versatile Choice

JOSKIN offers a **standardised, articulated filling arm** that can be fitted with numerous options to adapt to different types of pits.

- Self-supporting or built-in version
- 200 mm (8") or 250 mm (10") diameter
- Straight or angled arm, with or without turbo or equipped with a hydraulic extension
- Longer service life thanks to rigid hydraulic lines



Dorsal Boom with Front Pivot Point: the Most Efficient Choice



The advantage of the front-mounted dorsal boom is that it provides an **excellent visibility** to the driver when operating it. It can reach a maximal lifting angle when pumping from an off-ground container or tank, and a maximal diving angle when pumping from an underground pit.

- 340° swivel with safety switch
- Manual storage, or automatic with Isobus as an option
- Compatibility with all spreading implements
- 2 boom lengths with different equipment options: telescopic devices, turbo-filler, suction on funnel, etc.



SLURRY T

DISCOUNT PER M³

Up to - € 7,628 NET

Offer valid until 31.01.2025.

Tank always galvanised inside and outside for a long-lasting protection against corrosion + possibility of painting over the galvanisation

Pre-equipment for spreading implements and rear linkage (category 2)

Wide choice of wheels

Air compressor for tyre inflation system





TANKERS

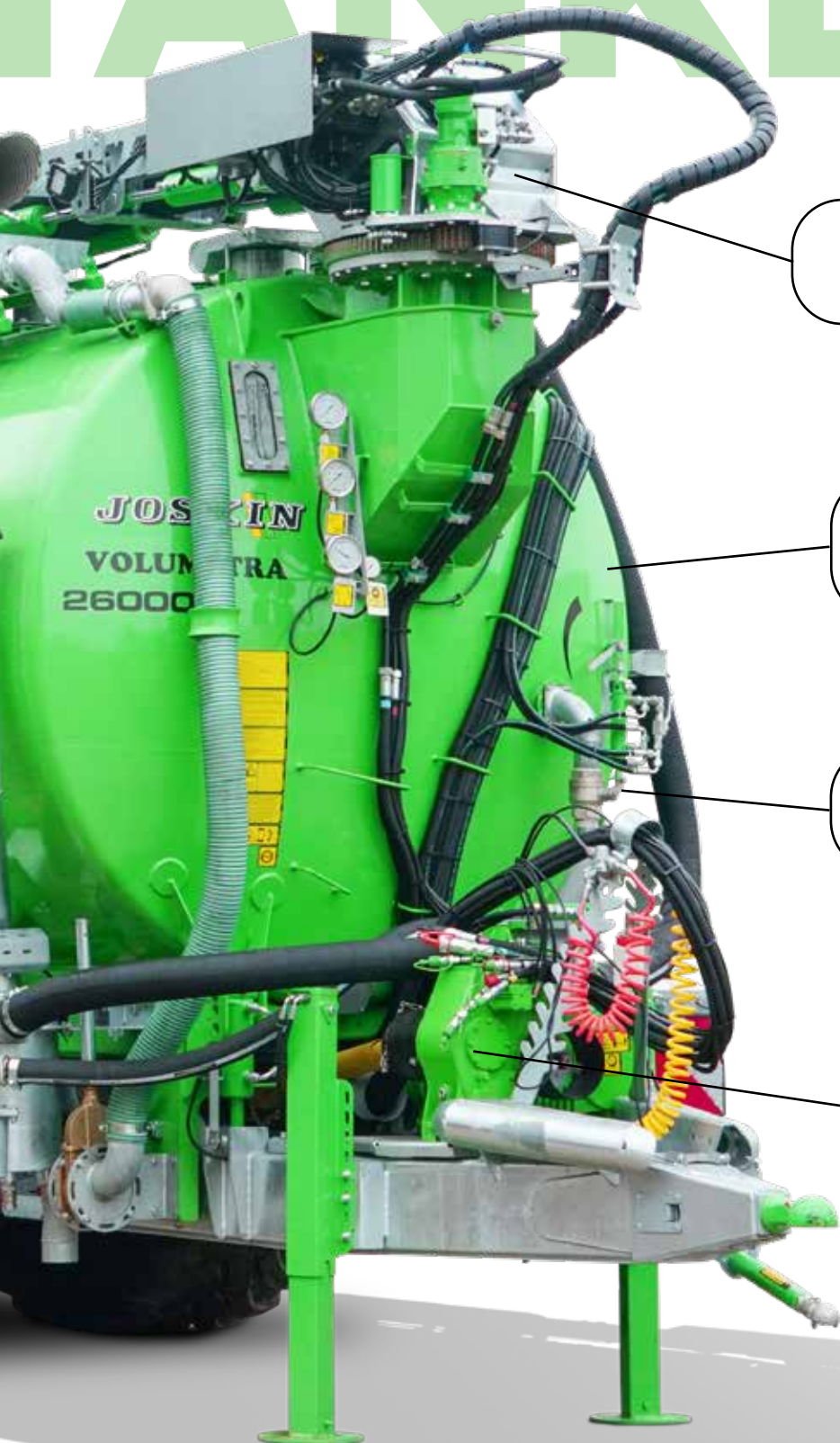

Tankers compatible with a wide range of booms and filling arms

Modular machines that can evolve through time thanks to many pieces of pre-equipment and a wide range of more than 900 options

Automated, mastered control for all tractor brands

Tankers compatible with a wide range of pumps

Scan the QR code and configure your slurry tanker in a few clicks!



Wide Range of Slurry Tankers

With **40 years of experience** and over **40,000 tankers sold** to this day, JOSKIN has a widely recognised technical expertise on the international level. From the simplest to the most technological one, our slurry tankers meet the highest requirements in terms of standards, reliability, sturdiness, safety and after-sales service with an individualised spare parts book, making your JOSKIN machine a sure bet on the international market.

Self-Supporting Chassis



A large part of our range is based on a **self-supporting structure** (chassis **A** welded **B** to the tank **C** along its entire length).

- *Evenly distributed tensile stresses*
- *Reduced overall weight*
- *Better manoeuvrability*
- *Lower centre of gravity = better traction and safety on uneven ground*

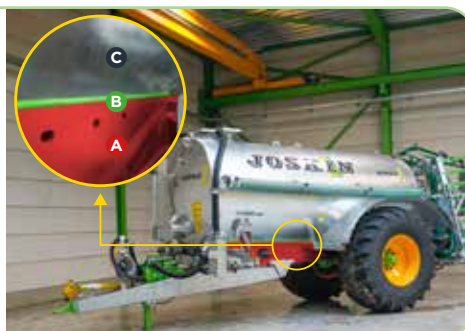

Alpin2 (4 models)
Ideal for mountainous regions
Capacity: 6,031 to 8,043 l
Single axle (lowered)
Pumps:



Modulo2 (17 models)
"Infinitely" adaptable tanker
Capacity: 2,529 to 20,185 l
Single or double axle
Pumps:





- € 150 NET/m³
= up to - € 2,340

Cobra2 (6 models)

Ultra compact tanker, champion in the fields

Capacity: 11,800 to 15,600 l

Single axle with large wheel diameter

Pumps:



- € 200 NET/m³
= up to - € 3,280

Tetrax2 (4 models)

Ideal to avoid ground compaction

Capacity: 10,755 to 16,400 l

4 large-diameter wheels on the same axle line

Pumps:



- € 200 NET/m³
= up to - € 5,666

Volumetra (10 models)

Large volume on self-supporting chassis

Capacity: 12,763 to 28,331 l

Double or triple axle

Pumps:



- € 250 NET/m³
= up to - € 7,628

X-Trem2 (8 models)

The tanker that pushes the limits of the extreme

Capacity: 16,490 to 30,510 l

Double or triple axle

Pumps:



- € 250 NET/m³
= up to - € 7,000

Tetraliner (6 models)

Off-road transport tanker

Capacity: 21,055 to 28,000 l

3 axles (rear tandem with spring leaves or air suspension depending on model, with or without self-supporting front Dolly)

Pumps:

Max. 4 t



Independent Chassis



Some tankers are mounted on an **independent universal chassis**, making them particularly suitable for heavy-duty work.

- All stresses concentrated directly on the chassis (integral tank protection)
- Compatible with all spreading systems
- Load distribution adapted to the weight of the rear implement



- € 225 NET/m³
= up to - € 4,542

Quadra (3 models)

Large volume, sturdy and better suited to difficult terrain

Capacity: 15,501 to 20,185 l

Double axle (Hydro-Tandem) with independent chassis and tank reinforcing bracket

Pump:



- € 250 NET/m³
= up to - € 7,513

Euroliner (6 models)

Large volume, more suitable for road travel

Capacity: 20,053 to 30,053 l

Triple axle (Hydro-Tridem) with independent chassis and tank reinforcing bracket

Pumps:





Alpina2



ACTION
- € 175 NET/m³



Modulo2



ACTION
- € 175 NET/m³



Cobra2



ACTION
- € 150 NET/m³



Tetrax2



ACTION
- € 200 NET/m³



X-Trem2



ACTION
- € 250 NET/m³



Volumetra



ACTION
- € 200 NET/m³



Quadra



ACTION
- € 225 NET/m³



Euroliner

ACTION
- € 250 NET/m³



Tetrainer



ACTION
- € 250 NET/m³

JOSKIN Advantages

Long-Term Guaranteed Follow-Up and Quality



Expertise in **research and development**



Expertise in **production automation**



Expertise in **surface treatment (galvanising and painting)** for a quality assurance



IT expertise for an **easy, ongoing follow-up with our dealers**

SLURRY TANKER ACTION
- € 150 to - € 250 NET/m³
Up to € 7,628 NET discount! Offer valid until 31.01.2025.
Offer subject to conditions.



Expertise in spare parts with an **individualised spare parts book** generated automatically and digitally on MyJOSKIN using the chassis number (ensuring the long-term financial value of all JOSKIN machines)



Expertise in after-sales service with a **3-year warranty** and a **permanent stock of spare parts**

